

# LED DOWNLIGHT

VEC-46315/VEC-46268/VEC-46269/VEC-46303

# VECTA



## WARNING

1. Switch off before installation.
2. Switch on only after complete installation and examination of the circuit.
3. Professional electrician for installation and maintenance only.

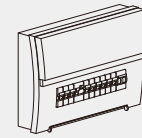

**Turn Off  
Power Supply**

Step1. Drill an appropriate installation hole in the ground

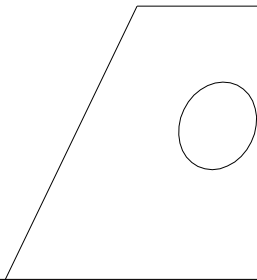

Step2. Place the embedded sleeve into the installation hole and secure it

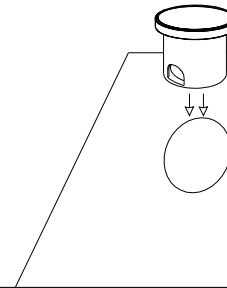

Step3. Connect the power cable properly and ensure it is waterproof

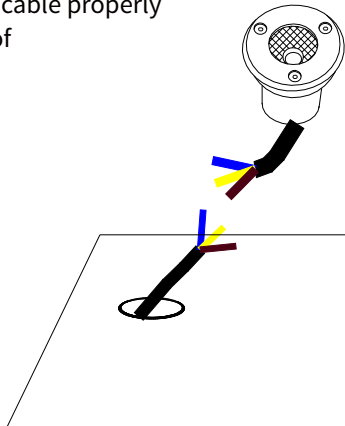

Step4. Install the light fixture into the pre-embedded mounting tube

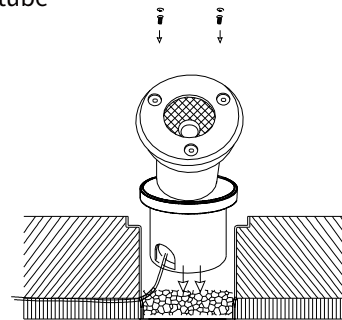

Step5. Complete the lighting installation

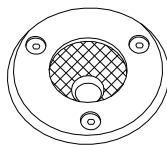

Step6. Make sure the lamp fixed tightly in ceiling, turn on the power.

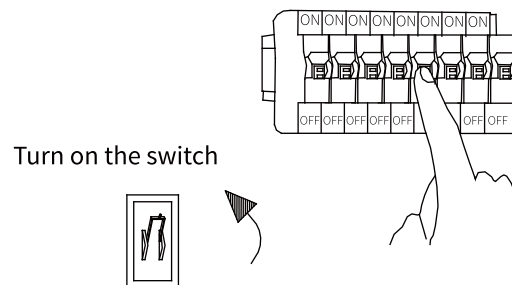

Caution: Please note that DO NOT use this product in the following places/application.

1. The place has a large quantity of chemical corrosive substance, such as: chemical plant and stockyard etc.
2. The place has poor temperature conditions, large-scale temperature variation, which would easily lead to broken and damage the product, the applicable operating temperature is between -20 and 40 degrees.

