

# LED TRACK LIGHT

VEC- 46173/VEC-46174

# VECTA



## WARNING

1. Switch off before installation.
2. Switch on only after complete installation and examination of the circuit.
3. Professional electrician for installation and maintenance only.

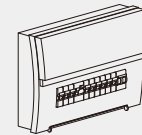

**Turn Off Power Supply**

step 1. Install the light source GU10

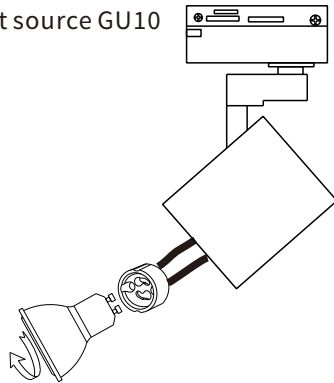

step 2. Make the power adaptor set to OFF

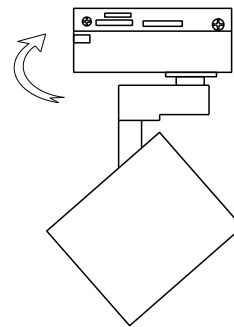

Step3. Make the led track light put into the track bar

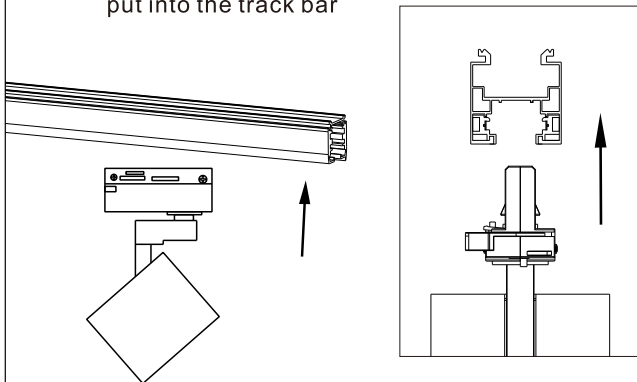

Step4. Turn the handle 90 degrees according the direction as shown in the picture , make sure the adaptor be locked in the track bar

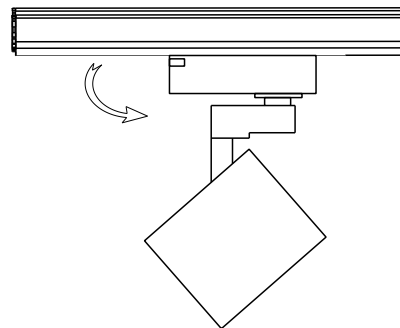

Step5. Adjust the illumination angle of the lamp

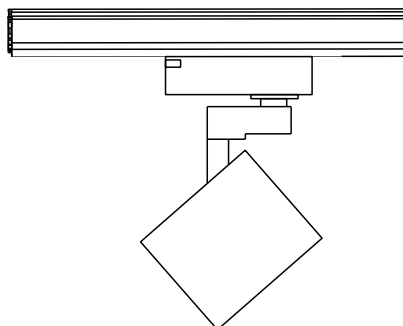

step 6. Make sure the tracklight fixed tightly in track, turn on the power.

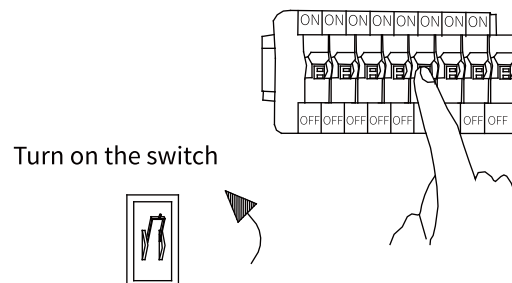

Caution: Please note that DO NOT use this product in the following places/application.

1. The place has a large quantity of chemical corrosive substance, such as: chemical plant and stockyard etc.
2. The place has poor temperature conditions, large-scale temperature variation, which would easily lead to broken and damage the product, the applicable operating temperature is between -20 and 40 degrees.

